

NOMAD

Àlex Fernández Camps
2024

durbanis

Sizes in cm

Material: Recycled Polyethylene LMDPE. UV Resistance.

Weight: 5kg.

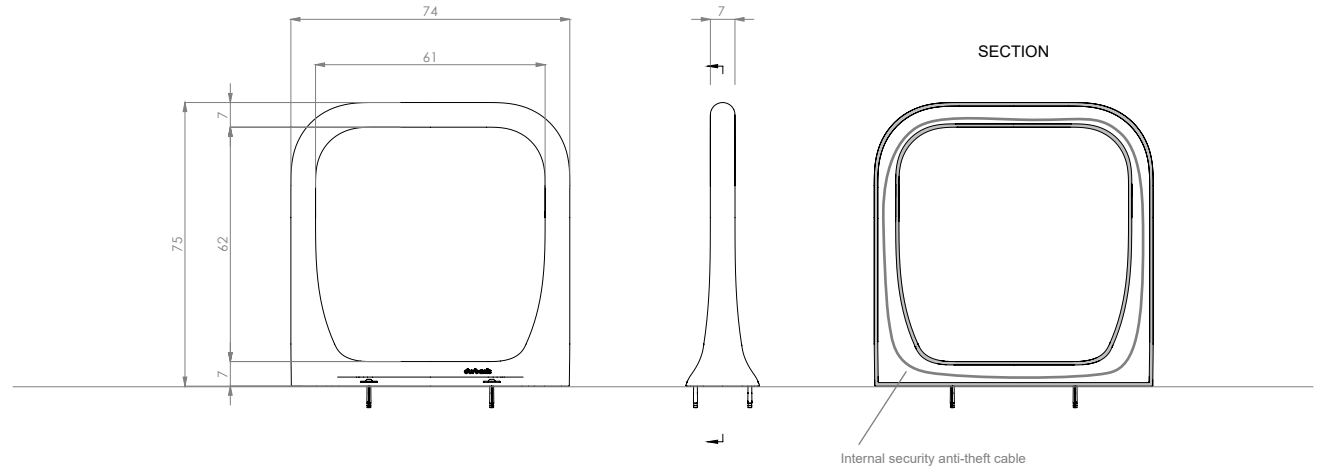
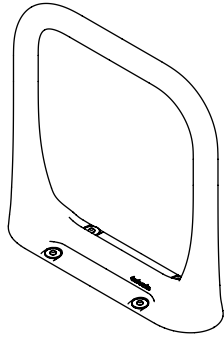

Placement system

Fixing with embedded anti-theft bolts into the pavement.

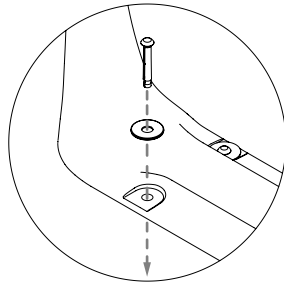
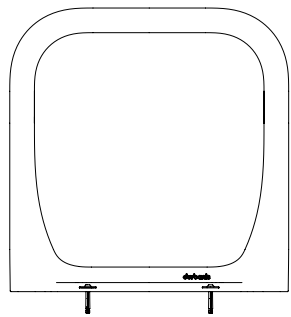

Drill pavement $\varnothing 12$ mm holes and tightly screw 4 anti-theft bolts M10 x 60 provided.

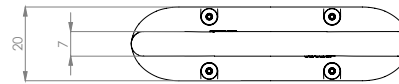
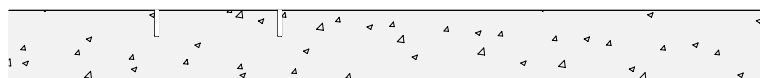
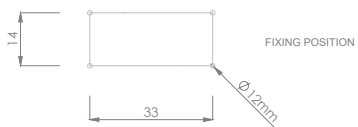

INSTALLATION

